

PD662 LOOP-POWERED METER

Instruction Manual



Survivor

- 4-20 mA Input Loop-Powered
- -1999 to 2999 Display
- Easy Four-Button Programming
- NEMA 4X Enclosure
- Programmable Noise Filter
- Loop-Powered Backlight Option
- 1.7 Volt Drop without Backlight
- HART Protocol Transparent
- CSA Certified for -40 to 75°C Operation (-55 to 75°C with Heater Option)

PRECISION DIGITAL CORPORATION
89 October Hill Road • Holliston MA 01746 USA
Tel (800) 343-1001 • Fax (508) 655-8990

**PRECISION
DIGITAL**

www.predig.com

Disclaimer

The information contained in this document is subject to change without notice. Precision Digital makes no representations or warranties with respect to the contents hereof; and specifically disclaims any implied warranties of merchantability or fitness for a particular purpose.



CAUTION: Read complete instructions prior to installation and operation of the meter.



WARNING: Risk of electric shock or personal injury.



Warning

This product is not recommended for life support applications or applications where malfunctioning could result in personal injury or property loss. Anyone using this product for such applications does so at his/her own risk. Precision Digital Corporation shall not be held liable for damages resulting from such improper use.

Limited Warranty

Precision Digital Corporation warrants this product against defects in material or workmanship for the specified period under "Specifications" from the date of shipment from the factory. Precision Digital's liability under this limited warranty shall not exceed the purchase value, repair, or replacement of the defective unit.

Registered Trademarks

All trademarks mentioned in this document are the property of their respective owners.

© 2010 Precision Digital Corporation. All rights reserved.

www.predig.com

INTRODUCTION

The PD662 NEMA 4X, CSA Certified loop-powered meter is perfect for applications where a simple, inexpensive display is required and AC power is not available. The PD662 derives all its power from the 4-20 mA loop. The PD662 is scaled using four push buttons and can be done without applying an actual calibration signal. The PD662's display will read up to 2999; we call this 3½+ digits! The loop-powered backlighting option lets you see the display under any lighting condition and is powered completely from the 4-20 mA loop. This means there is no need for additional wiring and never any batteries to change.

The PD662 is housed in a rugged NEMA 4X enclosure and is provided with one ½" NPT pipe conduit hole. The PD662 is also available with an optional DC-powered heater that allows the PD662 to operate in temperatures as low as -55°C.

ORDERING INFORMATION

Model	Description
PD662-0L0-00*	NEMA 4X, CSA Certified Loop-Powered Meter
PD662-0K0-00	NEMA 4X, CSA Certified Loop-Powered Meter with Backlight
PD662-0L0-A0	NEMA 4X, CSA Certified Loop-Powered Meter with Heater
PD662-0K0-A0	NEMA 4X, CSA Certified Loop-Powered Meter with Backlight & Heater

* Quick Shipment Program product, typically shipped within 2 working days

Accessories

Model	Description
PDA6624	Panel Mounting Kit
PDA6845	2" Pipe Mounting Kit

Table of Contents

INTRODUCTION	3
ORDERING INFORMATION	3
SPECIFICATIONS	6
General	6
Input	7
Heater	7
COMPLIANCE INFORMATION	8
Safety	8
Electromagnetic Compatibility	8
SAFETY INFORMATION	9
INSTALLATION	9
Unpacking	9
Mounting	10
PD662 Connections	10
Connection & Wiring Diagrams	11
SETUP AND PROGRAMMING	13
QUICK USER INTERFACE REFERENCE GUIDE	13
Front Panel Buttons	14
Main Menu Display Functions & Messages	15
Main Menu	16
Setting Numeric Values	16
Setting Up the Meter	17
Programming the Meter	17
Setting the Decimal Point (d^P)	18
Scaling the Meter (SCL)	18
Calibrating the Meter (CR_L)	19
Recalibrating the Internal Calibration Reference (iCR_L)	19
Advanced Features Menu	20
Advanced Features Menu & Display Messages	21
Information Menu (INF_0)	22
Input Signal Filter (FIL)	22
Internal Calibration (iCR_L)	23
OPERATION	24
Front Panel Buttons Operation	24
Maximum & Minimum Readings (Hl & Ll)	25

Reset Meter to Factory Defaults	26
Heater Operation.....	26
Factory Defaults & User Settings	27
MOUNTING DIMENSIONS	28
TROUBLESHOOTING.....	30
Troubleshooting Tips	30
QUICK USER INTERFACE REFERENCE GUIDE.....	31

Table of Figures

Figure 1. PD662 Mounting Board Rear View	11
Figure 2. PD662 Input Connections without Backlight	12
Figure 3. PD662 Input Connections with Backlight	12
Figure 4. PD662 Heater Power Connections	12
Figure 5. Case Dimensions – Front View	28
Figure 6. Case Dimensions – Side View	28
Figure 7. Case Dimensions – Bottom View	29
Figure 8. PDA6845 Pipe Mounting Kit.....	29

SPECIFICATIONS

Except where noted all specifications apply to operation at +25°C.

General

DISPLAY	0.6" (15.24 mm) LCD, 3½+ digits; -1999 to 2999
DISPLAY UPDATE RATE	2 Updates/Second
OVERRANGE	Display flashes 2999
UNDERRANGE	Display flashes - 1999
PROGRAMMING METHOD	Four internal pushbuttons
NOISE FILTER	Programmable HI , LO , or OFF
RECALIBRATION	Recalibration is recommended at least every 12 months.
MAX/MIN DISPLAY	Max/Min readings reached by the process are stored until reset by the user or until power to the meter is turned off.
NON-VOLATILE MEMORY	All programmed settings are stored in non-volatile memory for a minimum of ten years if power is lost.
NORMAL MODE REJECTION	64 dB at 50/60 Hz
ENVIRONMENTAL	Operating temperature for CSA certification: -40 to 75°C Functional temperature range: -40 to 85°C Storage temperature range: -40 to 85°C Relative humidity: 0 to 90% non-condensing
CONNECTIONS	Removable screw terminals accept 12 to 22 AWG wire
ENCLOSURE	Impact resistant polyester plastic, body gray, cover clear with blue faceplate; NEMA 4X, IP66; ½" conduit hole provided at base.
MOUNTING	½" NPT pipe (0.865 in, 12.7 mm) conduit hole on bottom of enclosure. 0.166 in (4.2 mm) wall mounting holes located behind front cover screws.
TIGHTENING TORQUE	Screw terminal connectors: 4.5 lb-in (0.5 Nm)
OVERALL DIMENSIONS	4.33" x 3.15" x 2.76" (110 mm x 80 mm x 70 mm) 4.33" x 3.15" x 3.35" (110 mm x 80 mm x 85 mm) for models with heater option.
WEIGHT	10.4 oz (295 g)
WARRANTY	3 years parts and labor

Input

ACCURACY	±1 count	
TEMPERATURE DRIFT	50 PPM/°C from -40 to 85°C ambient	
DECIMAL POINT	User selectable decimal point	
MINIMUM SPAN	Input 1 & Input 2: 0.40 mA	
CALIBRATION RANGE	An <i>Error</i> message will appear if input 1 and input 2 signals are too close together.	
	Input Range	Minimum Span Input 1 & Input 2
	4-20 mA	0.40 mA
MAXIMUM VOLTAGE DROP	Without Backlight	With Backlight
	1.7 VDC @ 20 mA	3.7 VDC @ 20 mA
EQUIVALENT RESISTANCE	85 Ω @ 20 mA	185 Ω @ 20 mA
INPUT OVERLOAD	Over current protection to 2 A max.	

Heater

POWER	24 VDC, 11 W max.
REQUIRED SWITCH & FUSE	A CSA Approved fuse rated min 30 VDC, 1 A, T and a readily accessible switch or a circuit breaker shall be provided to facilitate the disconnection of power to the heater.
OPERATION METHOD	On/Off control with an internal temperature sensor. Heater is on only when necessary due to external temperatures.
TEMPERATURE CUTOFF	Internal 104°C thermal cutoff for over temperature protection.
ENVIRONMENTAL (with Heater)	Operating temperature for CSA certification: -55 to 75°C Functional temperature range: -55 to 85°C Storage temperature range: -40 to 85°C Relative humidity: 0 to 90% non-condensing

COMPLIANCE INFORMATION

Safety

CSA CERTIFIED	U.S. & Canada 2252 05 – Process Control Equipment 2252 85 – Process Control Equipment, U.S. Standards
CSA FILE NUMBER	157123
CSA APPLICABLE REQUIREMENTS	CAN/CSA C22.2 No. 61010-1-04 Safety Requirements for Electrical Equipment for Measurement, Control, and Laboratory Use – Part 1: General Requirements UL 61010-1:2004, 2 nd Edition Safety Requirements for Electrical Equipment for Measurement, Control, and Laboratory Use – Part 1: General Requirements
LOW VOLTAGE DIRECTIVE	EN 61010-1:2001 Safety requirements for measurement, control, and laboratory use IEC 61010-1:2001 Safety requirements for measurement, control, and laboratory use

Electromagnetic Compatibility

EMC EMISSIONS & IMMUNITY	EN 61326-1:2006 EMC requirements for Electrical equipment for measurement, control and laboratory use - Industrial
-------------------------------------	---

SAFETY INFORMATION



CAUTION: Read complete instructions prior to installation and operation of the meter.

The equipment shall be installed by qualified personnel in accordance with applicable local and national regulations (e.g. CEC, NEC, FCC, SCC, etc).

Follow all safety and operation guidelines in this manual. If the meter is used in a manner not recommended by the manufacturer, the overall safety will be impaired.

Installation and service should be performed only by trained service personnel.

This unit is not suitable for hazardous locations such as potentially explosive zones or locations.

No user replaceable part inside. All service shall be performed at the factory.

Do not disconnect and reconnect cables during a lightning storm.

Suitable surge suppressor (e.g. lightning protection) shall be provided in end application installation.

INSTALLATION

All pushbuttons and wiring connectors are accessed by opening the NEMA 4X enclosure by removing the 4 captive screws that secure the cover.



Unpacking

Remove the meter from box. Inspect the packaging and contents for damage. Report damages, if any, to the carrier. If any part is missing or the meter malfunctions, please contact your supplier or the factory for assistance.

Mounting

The PD662 can be wall mounted using the mounting holes beneath the cover screws. A ½" NPT pipe conduit hole is provided. It can be panel mounted with the addition of the PDA6624 panel mount kit. It can also be pipe mounted by using the PDA6845 pipe mount kit.

Refer to *Mounting Dimensions*, page 28 for details on wall or panel space requirements.

	The unit shall be installed in a way that will prevent any accidental contact of the internal meter circuits and power supply lines.
	Cable suitable for outdoor use and a CSA Approved gland rated 4X, or a suitable conduit and a CSA Approved connector rated 4X, is intended to be used in final installation.
	Metallic conduit shall be reliably bonded to protective earth/ground without creating any ground loop.

PD662 Connections

	Disconnect power before opening the unit.
---	---

To access the connectors, remove the enclosure cover and unscrew the two captive stainless steel screws on the rear mounting board. Remove the meter assembly from the enclosure. Signal connections are made to a three-terminal removable connector. The signal wiring terminal block is on the rear of the meter assembly.

- S+** 4-20 mA signal input positive terminal connection
- S-** 4-20 mA signal return/negative terminal connection
- X** Not connected (no backlight option)
- B-** 4-20 mA signal return/negative terminal when using the installed loop powered backlight option

Refer to Figure 1 for terminal positions on the rear of the mounting board inside the meter enclosure.

Meters with the heater option will also have a two terminal removable connector on the rear of the assembly. See Figure 4 for wiring details.

- P+** 24 VDC power positive terminal connection
- P-** 24 VDC power negative terminal connection

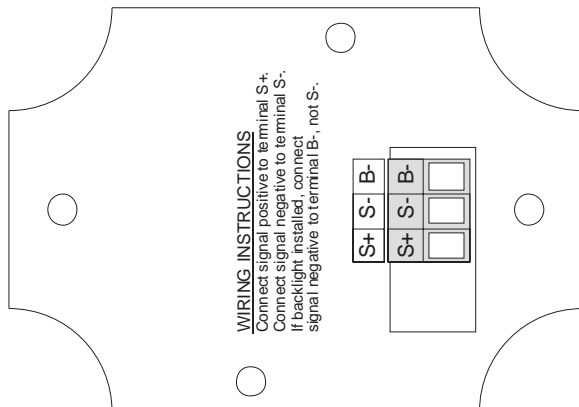

Figure 1. PD662 Mounting Board Rear View

Connection & Wiring Diagrams

Signal input connections are made to a three-terminal connector labeled S+|S-|X for models without a backlight and S+|S-|B- for models with a backlight. The 4-20 mA input with no backlight has a maximum voltage drop of 1.7 V and is wired as shown in Figure 2. The loop-powered backlight configuration requires a total maximum voltage drop of 3.7 V. The backlight is recommended for dim lighting conditions and is enabled when wired as shown in Figure 3.

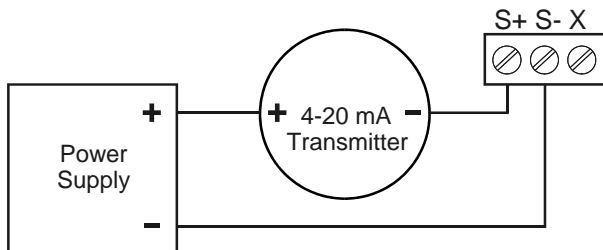

Figure 2. PD662 Input Connections without Backlight

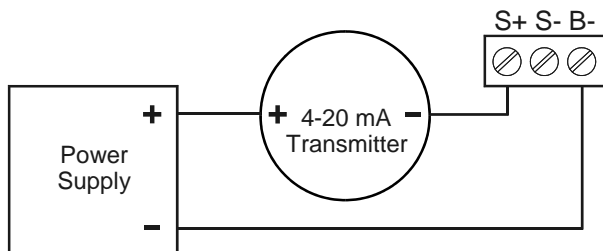

Figure 3. PD662 Input Connections with Backlight

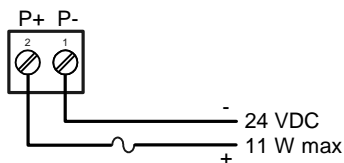

Figure 4. PD662 Heater Power Connections



A CSA Approved fuse rated min 30 VDC, 1 A, T and a readily accessible switch or a circuit breaker shall be provided to facilitate the disconnection of power to the heater.

SETUP AND PROGRAMMING

- There is **no need to recalibrate** the meter for milliamps when first received from the factory.
- The meter is **factory calibrated** for milliamps prior to shipment. The calibration equipment is certified to NIST standards.

Overview

There are no jumpers involved in the setup process of the meter. Setup and programming is done through the front panel buttons.

After all connections have been completed and verified, apply power to the loop.

For
QUICK USER INTERFACE REFERENCE GUIDE
go to page 31

Front Panel Buttons



Button/ Symbol	Description
MENU	Menu button to enter programming mode. Press and hold for 5 seconds to access the <i>Advanced</i> features of the meter.
ENTER	Enter button to access a menu or accept a setting.
▶	Right arrow to scroll through the menus or move to the next digit or decimal position during programming. Displays the Max then Min display values when pressed during normal run mode.
▲	Up arrow to scroll through the menus, decimal point, or to increment the value of a digit. Resets the Max and Min display value when pressed during normal run mode.

Main Menu Display Functions & Messages

The meter displays various functions and messages during setup, programming, and operation. The following table shows the main menu functions and messages in the order they appear in the menu.

Display	Parameter	Action/Setting
dP	<i>Decimal point</i>	Set decimal point
5L	<i>Scale</i>	Enter the <i>Scale</i> menu
in 1	<i>Scale Input 1</i>	Input signal 1 value (mA)
d 1	<i>Scale Display 1</i>	Scaled value for input 1
in 2	<i>Scale Input 2</i>	Input signal 2 value (mA)
d 2	<i>Scale Display 2</i>	Scaled value for input 2
LR	<i>Calibrate</i>	Enter the <i>Calibrate</i> menu
in 1	<i>Calibrate Input 1</i>	Read input signal 1
d 1	<i>Calibrate Display 1</i>	Enter value for input 1
in 2	<i>Calibrate Input 2</i>	Read input signal 2
d 2	<i>Calibrate Display 2</i>	Enter value for input 2

Main Menu

The main menu consists of the most commonly used functions: *Decimal Point Location*, *Scale*, and *Calibration*.

- Press **Menu** button to enter Programming Mode then press the **Up arrow** button to scroll main menu.

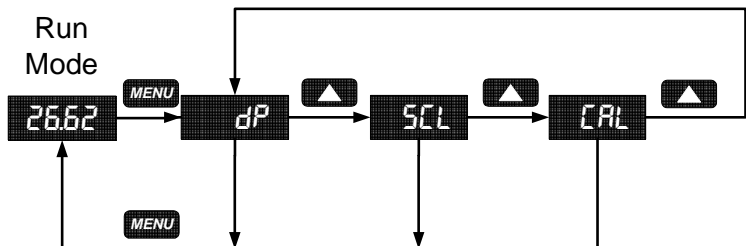

- Press **Menu**, at any time, to exit and return to Run Mode. Changes made to settings prior to pressing **Enter** are not saved.
- Changes to the settings are saved to memory only after pressing **Enter**.
- The display moves to the next menu every time a setting is accepted by pressing **Enter**.

Setting Numeric Values

The numeric values are set using the **Right** and **Up** arrow buttons. Press **Right** arrow to select next digit and **Up** arrow to increment digit. The two left-most digits on the display are set as a single digit, able to display -19 to 29.

The digit being changed blinks.

Press the **Enter** button, at any time, to accept a setting or **Menu** button to exit without saving changes.

The decimal point is set using the **Right** or **Up** arrow button in the *Setup-decimal point* menu.

Setting Up the Meter

Press the **Enter** button to access any menu or press **Up** arrow button to scroll through choices. Press the **Menu** button to exit at any time.

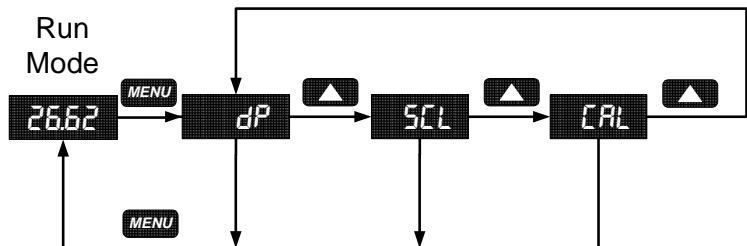

Programming the Meter

It is **very important** to read the following information, before proceeding to program the meter:

- There is **no need to recalibrate** the meter for milliamps when first received from the factory.
- The meter is **factory calibrated** for milliamps prior to shipment. The calibration equipment is certified to NIST standards.
- Use the *Scale (SCL)* menu to enter scale parameters without applying a live signal.
- Alternatively, use the *Calibrate (CAL)* menu to apply a signal from a calibrator or a 4-20 mA transmitter to calibrate the meter.

Inputs may be calibrated or scaled to any display within the range of the meter.

Additional parameters, not needed for most applications, are viewed and programmed with the *Advanced* features menu, see *Advanced Features Menu*, page 21.

Minimum Input Span

The minimum input span is the minimum difference between input 1 and input 2 signals required to complete the calibration or scaling of the meter. The minimum span is 0.40 mA.

If the minimum span is not maintained, the meter reverts to input 2, allowing the appropriate input signals to be applied.

Setting the Decimal Point (dP)

Decimal point may be set with up to three decimal places or with no decimal point at all.

Pressing the **Right** or **Up** arrow moves the decimal point one place to the right until no decimal point is displayed, then it moves to the left most position.

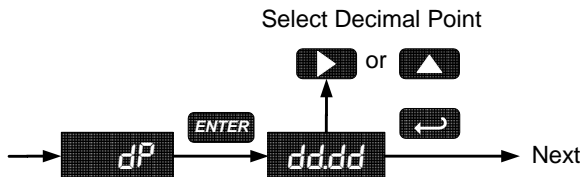

Scaling the Meter (SCL)

The 4-20 mA input can be scaled to display the process in engineering units.

A signal source is not needed to scale the meter; simply program the inputs and corresponding display values.

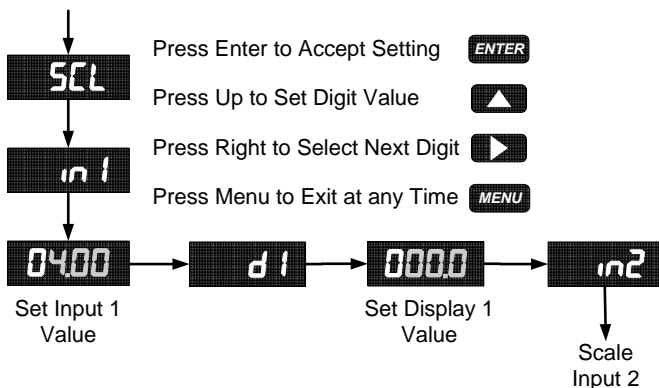

For instructions on how to program numeric values see *Setting Numeric Values*, page 16.

Calibrating the Meter (CAL)

To scale the meter without a signal source refer to *Scaling the Meter (SCALE)*, page 18.

The meter can be calibrated to display the process in engineering units by applying the appropriate input signal and following the calibration procedure.

The use of a calibrated signal source is strongly recommended.

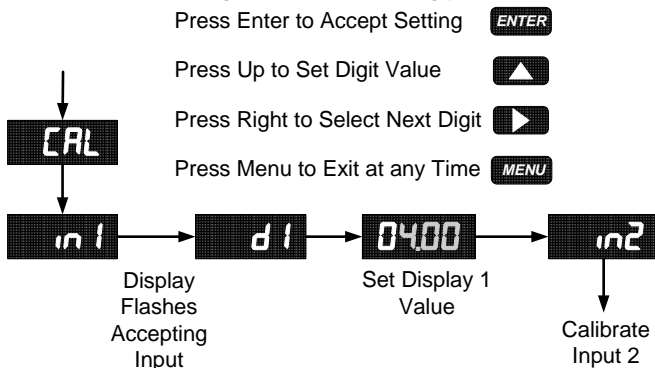

1. Press the **Up** arrow button to scroll to the *Calibration* menu (CAL) and press **Enter**.
2. The meter displays *in 1*. Apply a known signal and press **Enter**. The display will flash while accepting the signal.
3. After the signal is accepted, the meter displays *d 1*. Press **Enter**. Enter a corresponding display value for the signal input, and press **Enter** to accept.
4. The meter displays *in 2*. Apply a known signal and press **Enter**. The display will flash while accepting the signal.
5. After the signal is accepted, the meter displays *d 2*. Press **Enter**. Enter a corresponding display value for the signal input, and press **Enter** to accept.

Recalibrating the Internal Calibration Reference (ICAL)

The *Internal Calibration* (ICAL) menu, located in the *Advanced* features menu, is used to recalibrate the internal calibration reference.

Recalibration is recommended at least every twelve months. Refer to *Internal Calibration* (ICAL), page 23 for instructions.

Advanced Features Menu

To simplify the setup process, functions not needed for most applications are located in the *Advanced* features menu. Press and hold the **MENU** button for five seconds to access the *Advanced* features menu

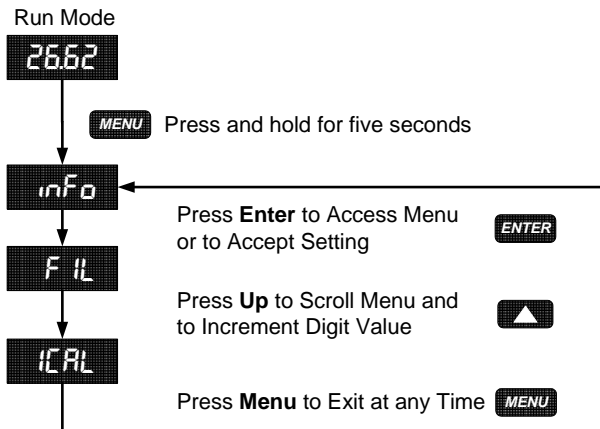

Advanced Features Menu & Display Messages

The following table shows the *Advanced* features menu functions and messages in the order they appear in the menu.

Display	Parameter	Action/Setting
INF0	Information	Enter the <i>Information</i> menu
5Ft	Software Information	Software release number
UEr	Version	Meter firmware version
°C	Calibration Temp (°C)	Temperature at time of I-calibration (°C)
°F	Calibration Temp (°F)	Temperature at time of I-calibration (°F)
F IL	Filter	Set filter function level
iCAL	I-Calibration	Internal master factory calibration
rSt	Reset Defaults	Restore factory default parameter settings

For instructions on how to program numeric values see *Setting Numeric Values*, page 16.

Information Menu (*INFA*)

The *Information* menu is located in the *Advanced* features menu, to access *Information* menu see *Advanced Features Menu*, page 20.

It shows software identification number, version number, and calibration temperatures. To determine the software version of a meter:

1. Go to the *Information* menu (*INFA*) and press **Enter** button.
2. The meter will automatically scroll through the software release number and software version. The meter temperatures at the time of last internal calibration in °C and °F are displayed for calibration troubleshooting. Pressing the **ENTER**, **RIGHT**, or **UP** buttons will progress the information display.
3. Following the information display, the meter will exit the *Advanced* features menu and return to run mode.

Input Signal Filter (*F IL*)

The noise filter is available for unusually noisy signals that cause an unstable process variable display. The noise filter averages the input signal over a certain period. The filter level can be set to low (*LI*), high (*HI*), or off (*OFF*). The higher the filter setting, the longer the averaging time and so the longer the display may take to find its final value.

The filter contains a noise filter bypass feature so that while small variations in the signal will be filtered out, large, abrupt changes to the input signal are displayed immediately.

Internal Calibration (*ICRL*)

- There is **no need to recalibrate** the meter for milliamps when first received from the factory.
- The meter is **factory calibrated** for milliamps prior to shipment. The calibration equipment is certified to NIST standards.

The internal calibration allows the user to scale the meter without applying a signal. The use of a calibrated signal source is necessary to perform the internal calibration of the meter. Check calibration of the meter at least every 12 months.

Notes:

- The signal source must have a full-scale accuracy of 0.01% or better between 4 and 20 mA in order to maintain the specified accuracy of the meter.
- Allow the meter to warm up for at least 15 minutes before performing the internal calibration procedure.

The *Internal calibration* menu is part of the *Advanced* features menu.



1. Press and hold the **MENU** button for 5 seconds to enter the *Advanced* features menu.
2. Press the **Up** arrow button to scroll to the *Internal Calibration* menu (*ICRL*) and press **Enter**.
3. The meter displays 4.00 mA. Apply a 4.00 mA signal and press **Enter**. The display flashes for a moment while the meter is accepting the signal.
4. After the signal is accepted, the meter displays 20.00 mA. Apply a 20.00 mA signal and press **Enter**. The display flashes for a moment while the meter is accepting the signal.

Error Message (Err)

An error message indicates that the calibration process was not successful. After the error message is displayed, the meter will revert to input 2 calibration settings. The error message might be caused by inadvertently leaving the signal at the previous level or not maintaining a 0.40 mA minimum span. Press the Menu button to cancel the current calibration process if necessary.

OPERATION

Front Panel Buttons Operation

Button Symbol	Description
MENU	Press to enter or exit Programming Mode or exit Max/Min readings
	Press to reset Max/Min readings
	Press to display Max/Min readings alternately
ENTER	Press to display Max or Min reading indefinitely while displaying Max or Min

Maximum & Minimum Readings (HI & LO)

The maximum and minimum (peak & valley) readings reached by the process are stored in the meter since the last reset or power-up. The meter flashes *HI* or *LO* to differentiate between run mode and max/min display.

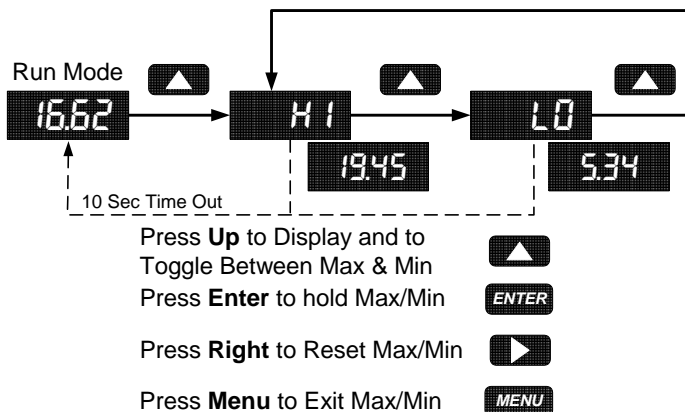

1. Press **Up** arrow button to display maximum reading since the last reset/power-up.
2. Press **Up** arrow again to display the minimum reading since the last reset/power-up.
3. Press **Enter** to continue to display the Max or Min display reading by disabling the Max/Min timeout. The meter will continue to track new Max/Min readings. Press **MENU** to exit the Max/Min reading.
4. If **Enter** is not pressed, the Max/Min display reading will continue to flash and time out after ten seconds. The meter will return to display the actual reading.
5. Press **Right** arrow button while in Max/Min Mode to reset both Max and Min. Max/Min display readings are reset to the current reading.

Reset Meter to Factory Defaults

When the parameters have been changed in a way that is difficult to determine what's happening, it might be better to start the setup process from the factory defaults.

Instructions to load factory defaults:

1. Enter the *Advanced* features menu. See *Advanced Features Menu*, page 20.
2. Press **RIGHT** arrow button when *info* is shown.
3. Press **ENTER** button when *rSt* is shown.
Press **Enter** again when display flashes *rSt*.
Note: If **Enter** is not pressed a second time within three seconds, *rSt* will stop flashing and the last **ENTER** press cancelled.
4. The meter goes through an initialization sequence (same as on power-up), and loads the factory default settings.

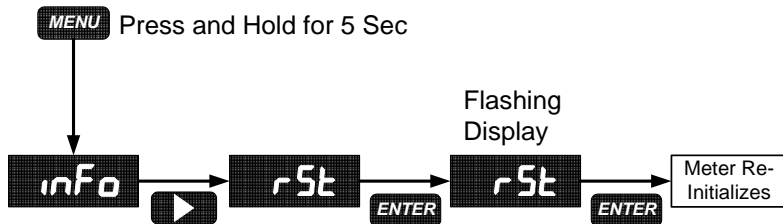

Heater Operation

Models with the integrated heater option require no additional setup. All heater operations are controlled automatically by the unit. An internal temperature sensor controls the operation of the heater. The heater is only on when required due to external temperatures.

Factory Defaults & User Settings

The following table shows the factory setting for most of the programmable parameters on the meter. Next to the factory setting, the user may record the new setting for the particular application.

Model: _____ S/N: _____ Date: _____

Parameter	Display	Default Setting	User Setting
<i>Decimal point</i>	<i>ddd</i>	2 places	
<i>Scale</i>	<i>5LL</i>		
<i>Input 1</i>	<i>in 1</i>	4.00 mA	
<i>Display 1</i>	<i>d 1</i>	4.00	
<i>Input 2</i>	<i>in 2</i>	20.00 mA	
<i>Display 2</i>	<i>d 2</i>	20.00	
<i>Advanced Features</i>			
<i>Filter</i>	<i>F IL</i>	Off	

MOUNTING DIMENSIONS

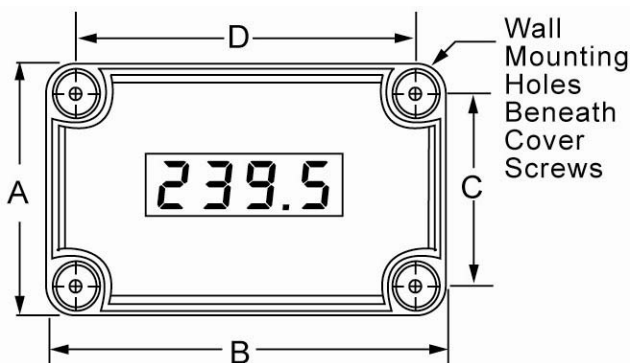

Figure 5. Case Dimensions – Front View

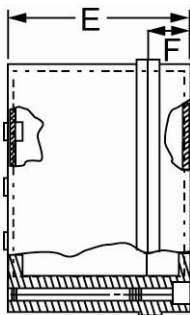

Figure 6. Case Dimensions – Side View

A: 3.15 in (80 mm) B: 4.33 in (110 mm) C: 2.44 in (62 mm)

D: 3.62 in (92 mm) E: 2.76 in (70 mm)
3.35 in (85 mm) with heater option

F: 0.79 in (20 mm); 1.38 in (35 mm) with heater option

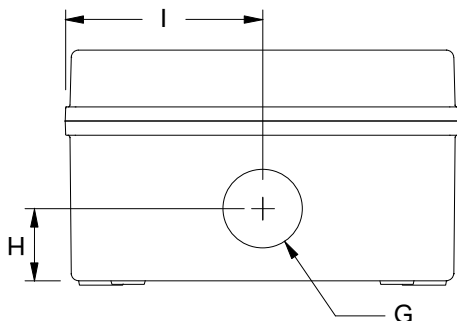

Figure 7. Case Dimensions – Bottom View

G: 0.87 in (22 mm)

H: 0.80 in (20 mm)

I: 2.17 in (55 mm)

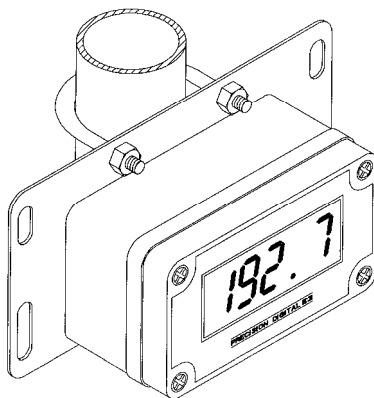

Figure 8. PDA6845 Pipe Mounting Kit

The PDA6845 pipe mounting kit may be used to mount a PD662 to a 2" pipe. The kit includes an 8.20 in (208 mm) x 4.10 in (104 mm) mounting panel with a 2" U-bolt and all necessary mounting hardware.

TROUBLESHOOTING

The rugged design and the user-friendly interface of the meter should make it unusual for the installer or operator to refer to this section of the manual.

If the meter is not working as expected, refer to the recommendations below.

Troubleshooting Tips

Symptom	Check/Action
No display or faint display	<ol style="list-style-type: none"> 1. Check connections. 2. Perform hard reset by temporarily shorting S+ and S- terminals for a few seconds.
Rate display unsteady	Increase filter setting in <i>Advanced</i> menu.
Meter displays error message during calibration (<i>Err</i>)	Check: <ol style="list-style-type: none"> 1. Signal connections 2. Minimum input span requirements
Meter flashes <ul style="list-style-type: none"> • 2999 • -1999 	Check: <ol style="list-style-type: none"> 1. Input signal within scaled range of 2999 and -1999.
Display stuck flashing a number and <i>H I</i> or <i>L 0</i>	Press Menu to exit Max/Min display readings.
Display response is too slow	Check filter setting to see if it can be lowered to <i>L 0</i> or <i>OFF</i> .
If the display locks up or the meter does not respond at all	Perform hard reset by temporarily shorting S+ and S- terminals for a few seconds and then removing short.
Backlight does not appear.	Check: <ol style="list-style-type: none"> 1. Meter has a backlight installed. 2. Signal connections are as shown in Figure 3 on page 12.
Other symptoms not described above	Call Technical Support for assistance.

QUICK USER INTERFACE REFERENCE GUIDE

<u>Pushbutton</u>	<u>Function</u>
Menu	Go to Programming Mode, leave Programming Mode, and Max/Min Mode. Hold for 5 seconds to access <i>Advanced Features</i> .
Right Arrow	Move to next digit or decimal point position. Reset Min/Max.
Up Arrow	Move to next selection or increment digit. Go to Max/Min Mode.
Enter	Accept selection/value and move to next selection.

Max/Min Mode

While in Run Mode, pressing **Up Arrow** will initiate Max/Min Mode. **Up Arrow** toggles between Max & Min displays, and **Right Arrow** resets the Max/Min to the current value. Press **Menu** or wait 10 seconds to return to Run Mode. Pressing **Enter** will disable the 10 second timeout and continuously flash Max or Min.

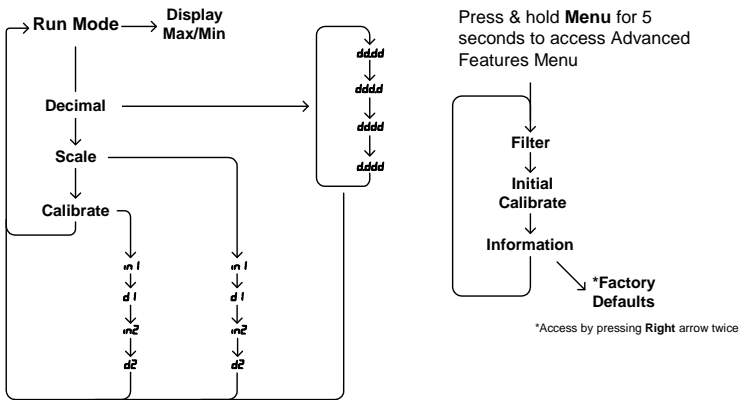

Operational Modes

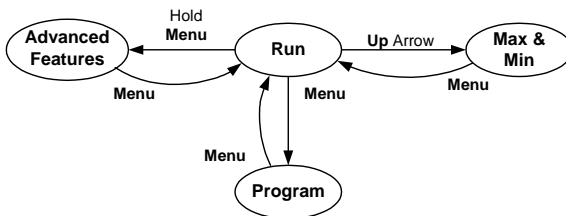

How to Contact Precision Digital

- For Technical Support:
Call: (800) 610-5239 or (508) 655-7300
Fax: (508) 655-8990
Email: support@predig.com
- For Sales Support:
Call: (800) 343-1001 or (508) 655-7300
Fax: (508) 655-8990
Email: sales@predig.com
- For the latest version of this manual please visit:
www.predig.com

