

Head-mounted Two-wire Signal Conditioners 27-UNIT

2-WIRE UNIVERSAL TEMPERATURE TRANSMITTER (HART communication)

Functions & Features

- Universal input: mV, T/C, RTD and resistance
- High accuracy
- HART communication
- Intrinsically safe approval
- Suitable for Functional Safety applications up to SIL2
- Programming via hand-held communicator or via PC
- A wide variety of T/C and RTD types
- User's temperature table can be used
- Self diagnostics
- Ultra-low temp. drift option (20 ppm/°C typ.)
- CE marking (conforms to ATEX and EMC)

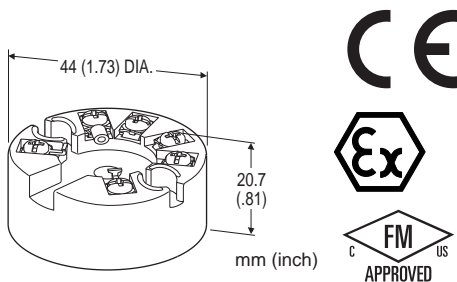

MODEL: 27HU-[1][2]

ORDERING INFORMATION

- Code number: 27HU-[1][2]

Specify a code from below for each [1], [2].
(e.g. 27HU-2)

Use Ordering Information Sheet (No. ESU-7651). Factory standard setting will be used if not otherwise specified. Specify the country in which the product is to be used with the Safety Approval code 2.

[1] SAFETY APPROVAL

0: None

1: FM intrinsically safe

2: CENELEC intrinsic safety (ATEX)

[2] OPTIONS

Temperature drift

Blank: Standard (temp. coefficient 0.015%/°C)

/L: Ultra-low temperature drift

(temp. coefficient 0.002%/°C typ., 0.005%/°C max.)

RELATED PRODUCTS

- RS-232C interface Bell202 modem (model: COP-H)
Usable in 'non-hazardous' area only.
- USB interface Bell202 modem (model: COP-HU)
Usable in 'non-hazardous' area only.
- Hand-held communicator
- PC configurator software (model: 27HUCFG)
Downloadable at M-System's web site.

GENERAL SPECIFICATIONS

Construction: Sensor head-mounting

Connection: M3 screw terminals (torque 0.5 N·m)

Screw terminal: Nickel-plated brass

Housing material: Flame-resistant resin (black)

Isolation: Input to output

User-configurable items:

- Input sensor type and numbers
- Number of wires (RTD & resistance)
- Input range (inverted range selectable)
- Burnout
- Output limits (Upper / Lower)
- Damping time (factory set to 0)
- Cold junction compensation (T/C; internal or external sensor selectable)
- Linearization
- Sensor calibration
- Output calibration
- HART communication mode

Refer to the HART setup manual or the PC configurator users manual for the detail.

HART COMMUNICATION

Protocol: HART communication protocol

HART address range: 0 - 15 (factory set to 0)

Transmission speed: 1200 bps

Digital current: Approx. 1 mA_{p-p} when communicating

Character format: 1 Start Bit, 8 Data Bits, 1 Odd Parity Bit, 1 Stop Bit

Distance: 1.5 km (0.9 miles)

HART communication mode: Master-Slave Mode and Burst Mode (factory set to Master-Slave)

HART network mode: Point-to-Point Mode and Multi-drop Mode; automatically set to Multi-drop Mode when the address is set to other than 0.

INPUT SPECIFICATIONS

The input is factory set for use with K thermocouple, single input, 0 to 100°C, internal CJC sensor.

See Table 1 for the available input type, the minimum span and the maximum range.

- DC mV (dual input available)

Input resistance: $\geq 1 \text{ M}\Omega$

• **THERMOCOUPLE (dual input available)**

Input resistance: $\geq 1 \text{ M}\Omega$

Burnout sensing: 33 μA

External CJC sensor type: Pt 100

• **RTD (2-wire, 3-wire or 4-wire)**

Input resistance: $\geq 1 \text{ M}\Omega$

Excitation: 0.2 mA

Allowable leadwire resistance: Max. 10 Ω per wire

• **RESISTANCE (2-wire, 3-wire or 4-wire)**

Input resistance: $\geq 1 \text{ M}\Omega$

Excitation: 0.2 mA

Allowable leadwire resistance: Max. 10 Ω per wire

OUTPUT SPECIFICATIONS

Output range: 4 - 20 mA DC

Operational range: 3.75 - 23 mA

Load resistance vs. supply voltage:

Load Resistance (Ω) = (Supply Voltage (V) - 8 (V)) / 0.023 (A) (including leadwire resistance)

Burnout: 3.75 - 3.8 mA or 21.5 - 23 mA (factory set to 23 mA)

Upper output limit proportional to the input:

20 - 21.5 mA (factory set to 21.5 mA)

Lower output limit proportional to the input:

3.8 - 4 mA (factory set to 3.8 mA)

Update time: 440 msec. (660 msec. with dual input)

Output characteristics for dual input:

Average or Differential selectable

INSTALLATION

Supply voltage:

- 8 - 35 V DC (non-approved)
- 8 - 28 V DC (approved)

Operating temperature: -40 to +85°C (-40 to +185°F)

(See Safety Parameters for use in a hazardous location.)

Operating humidity: 0 to 95 %RH (non-condensing)

Mounting: Head-mounting (DIN type B head)

Weight: 50 g (1.76 oz)

PERFORMANCE

Accuracy: See Table 1.

Cold junction compensation accuracy: $\pm 0.5^\circ\text{C}$ with internal CJC sensor

Response time: ≤ 2 sec. (0 - 90 %) with damping time set to 0 and when not communicating via HART.

Supply voltage effect: ± 0.05 % of span/V

Insulation resistance: $\geq 100 \text{ M}\Omega$ with 500 V DC

Dielectric strength: 1500 V AC @1 minute (input to output)

Safety integrity level according to IEC 61508: Suitable for

use in a safety instrumented system up to SIL2 (together with sensor) if appropriate safety instructions are observed. Consult M-System.

STANDARDS & APPROVALS

CE conformity:

ATEX Directive (94/9/EC)

Ex ia EN 60079-11

EMC Directive (2004/108/EC)

EMI EN 61000-6-4

EMS EN 61000-6-2

Safety approval:

FM: Intrinsically safe

Class I, Division 1, Groups A, B, C and D

Class I, Zone 0, AEx ia IIC (US)

Class I, Zone 0, Ex ia IIC (Canada)

T4, T5 and T6

(Class 3610, ANSI/ISA 60079-11,

CAN/CSA-C22.2 No. 157,

CAN/CSA-C22.2 No. 60079-11)

CENELEC: Intrinsic safety (ATEX)

 II 1G, Ex ia IIC; T4, T5 and T6 (EN 60079-11: 2007)

SAFETY PARAMETERS

Operating temperature

For CENELEC (ATEX) / FM:

T4: -40 to +80°C

T5: -40 to +60°C

T6: -40 to +45°C

Ex-data:

- Output circuit
 - Ui (Vmax): 30 V DC
 - Ii (Imax): 96 mA DC
 - Pi (Pmax): 720 mW
 - Ci: 1 nF
 - Li: 0 mH
- Sensor circuit
 - Uo (Voc): 30 V DC
 - Io (Isc): 24 mA DC
 - Po: 180 mW
 - Co (Ca): 50 nF
 - Lo (La): 40 mH

INPUT TYPE, RANGE & ACCURACY

INPUT TYPE, RANGE & ACCURACY

Table 1

INPUT TYPE	MINIMUM SPAN	MAXIMUM RANGE	ACCURACY *1	TEMPERATURE DRIFT				
				STANDARD DRIFT *2	ULTRA-LOW DRIFT *3			
DC mV	4 mV	-100 to +800 mV	±10 μV	±1.5 μV/°C	±0.5 μV/°C			
Resistance	25 Ω	0 to 4 kΩ	±0.1 Ω	±15 mΩ/°C	±5 mΩ/°C			
Thermocouple	°C			°F			TEMPERATURE DRIFT	
	MINIMUM SPAN	MAXIMUM RANGE	ACCURACY *1	MINIMUM SPAN	MAXIMUM RANGE	ACCURACY *1	STANDARD DRIFT *2	ULTRA-LOW DRIFT *3
K (CA)	50	-180 to +1372	±0.5	90	-292 to +2501	±0.9	±0.075°C/°C	±0.025°C/°C
E (CRC)	50	-100 to +1000	±0.5	90	-148 to +1832	±0.9	±0.075°C/°C	±0.025°C/°C
J (IC)	50	-100 to +1200	±0.5	90	-148 to +2192	±0.9	±0.075°C/°C	±0.025°C/°C
T (CC)	50	-200 to +400	±0.5	90	-328 to +752	±0.9	±0.075°C/°C	±0.025°C/°C
B (RH)	100	400 to 1820	±1	180	752 to 3308	±1.8	±0.3°C/°C	±0.1°C/°C
R	100	-50 to +1760*4	±1	180	-58 to +3200*4	±1.8	±0.3°C/°C	±0.1°C/°C
S	100	-50 to +1760*4	±1	180	-58 to +3200*4	±1.8	±0.3°C/°C	±0.1°C/°C
C (WRe 5-26)	100	0 to 2300	±1	180	32 to 4172	±1.8	±0.3°C/°C	±0.1°C/°C
D (WRe 3-25)	100	0 to 2300	±1	180	32 to 4172	±1.8	±0.3°C/°C	±0.1°C/°C
N	50	-180 to +1300	±0.5	90	-292 to +2372	±0.9	±0.075°C/°C	±0.025°C/°C
U	50	-200 to +600	±0.5	90	-328 to +1112	±0.9	±0.075°C/°C	±0.025°C/°C
L	50	-100 to +900	±0.5	90	-148 to +1652	±0.9	±0.075°C/°C	±0.025°C/°C
RTD	°C			°F			TEMPERATURE	
	MINIMUM SPAN	MAXIMUM RANGE	ACCURACY *1	MINIMUM SPAN	MAXIMUM RANGE	ACCURACY *1	STANDARD DRIFT *2	ULTRA-LOW DRIFT *3
Pt 100 (JIS '97, IEC)	10	-200 to +850	±0.1	18	-328 to +1562	±0.18	±0.015°C/°C	±0.005°C/°C
Pt 200	10	-200 to +850	±0.1	18	-328 to +1562	±0.18	±0.015°C/°C	±0.005°C/°C
Pt 500	10	-200 to +850	±0.1	18	-328 to +1562	±0.18	±0.015°C/°C	±0.005°C/°C
Pt 1000	10	-200 to +850	±0.1	18	-328 to +1562	±0.18	±0.015°C/°C	±0.005°C/°C
JPt 100 (JIS '89)	10	-200 to +510	±0.1	18	-328 to +950	±0.18	±0.015°C/°C	±0.005°C/°C
Ni 100 (DIN 43760 '87)	10	-60 to +250	±0.2	18	-76 to +482	±0.36	±0.015°C/°C	±0.005°C/°C

- *1. DC mV: Or ±0.05 % of absolute range (greater of 0 % and 100 % range values), whichever is greater.
Or ±0.2 % of absolute negative range for two inputs including negative ranges, whichever is greater.
- Resistance: Or ±0.05 % of absolute range (greater of 0 % and 100 % range values), whichever is greater.
- Thermocouple: Or ±0.05 % of span, whichever is greater. Add cold junction compensation error.
- RTD: Or ±0.05 % of max. range (greater of 0 % and 100 % range values converted into °C), whichever is greater.
(For 2- or 3-wire RTD, the value is valid by the sensor calibration after wiring is complete.)
- *2. Or ±0.015 % of absolute range/°C (greater of 0 % and 100 % range values), whichever is greater.
- *3. Or ±0.005 % of absolute range/°C (greater of 0 % and 100 % range values), whichever is greater.
- *4. Conformance range: 50 to 1760°C or 122 to 3200°F

DIMENSIONS unit: mm (inch)

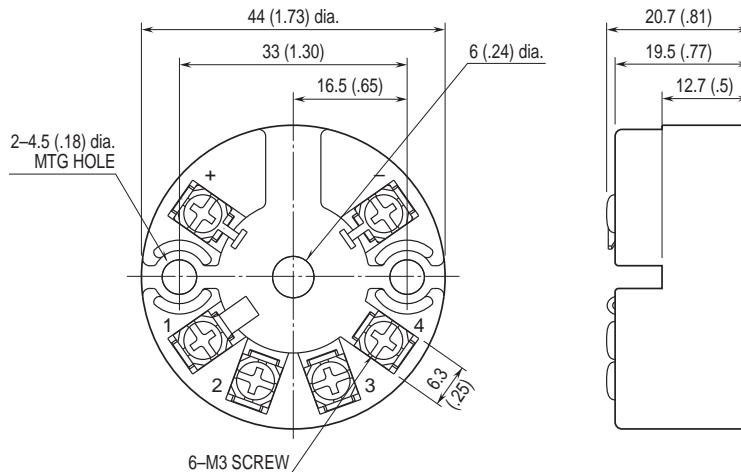

MOUNTING REQUIREMENTS unit: mm (inch)

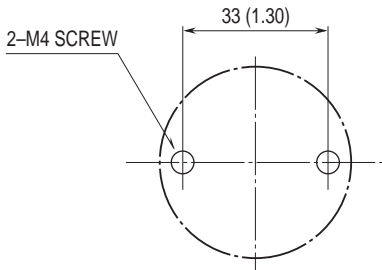

SCHEMATIC CIRCUITRY & CONNECTION DIAGRAM

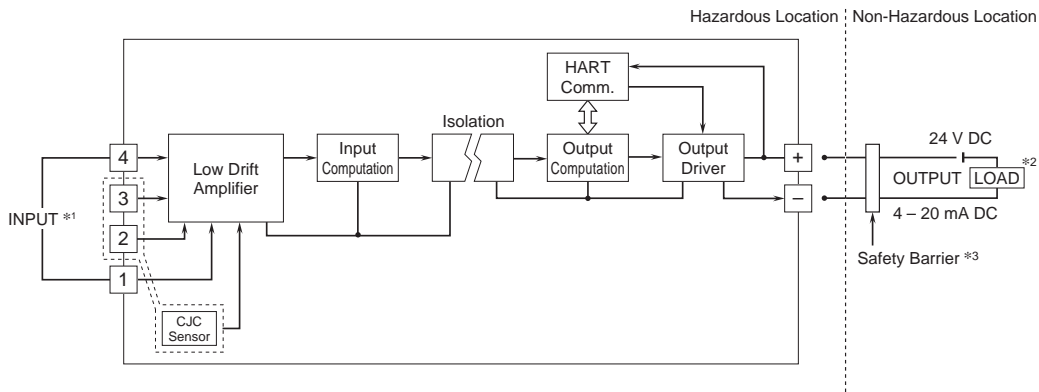

*1. Input Connection Examples

■ DC MILLIVOLT

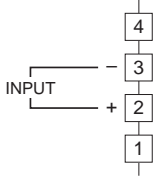

■ THEROCOUPLE

• Internal CJC

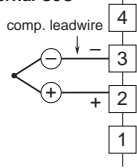

■ RTD & RESISTANCE

• Two-wire

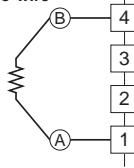

• Two Inputs

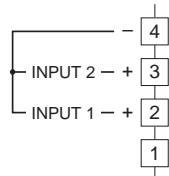

• External CJC

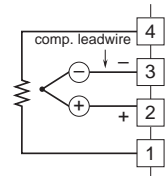

• Three-wire

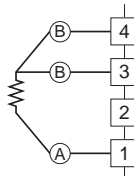

• Two Inputs, Internal CJC

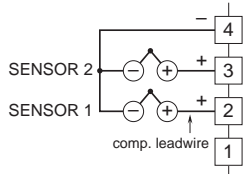

• Four-wire

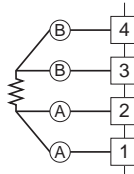

• Two Inputs, External CJC

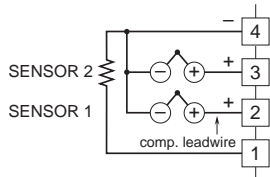

*2. Limited to 250 – 1100Ω for HART communication.

*3. A safety barrier must be installed for the intrinsic safety.

The safety barrier must meet the Ex-data of this unit and must be approved for the hazardous location.



Specifications are subject to change without notice.